

10'

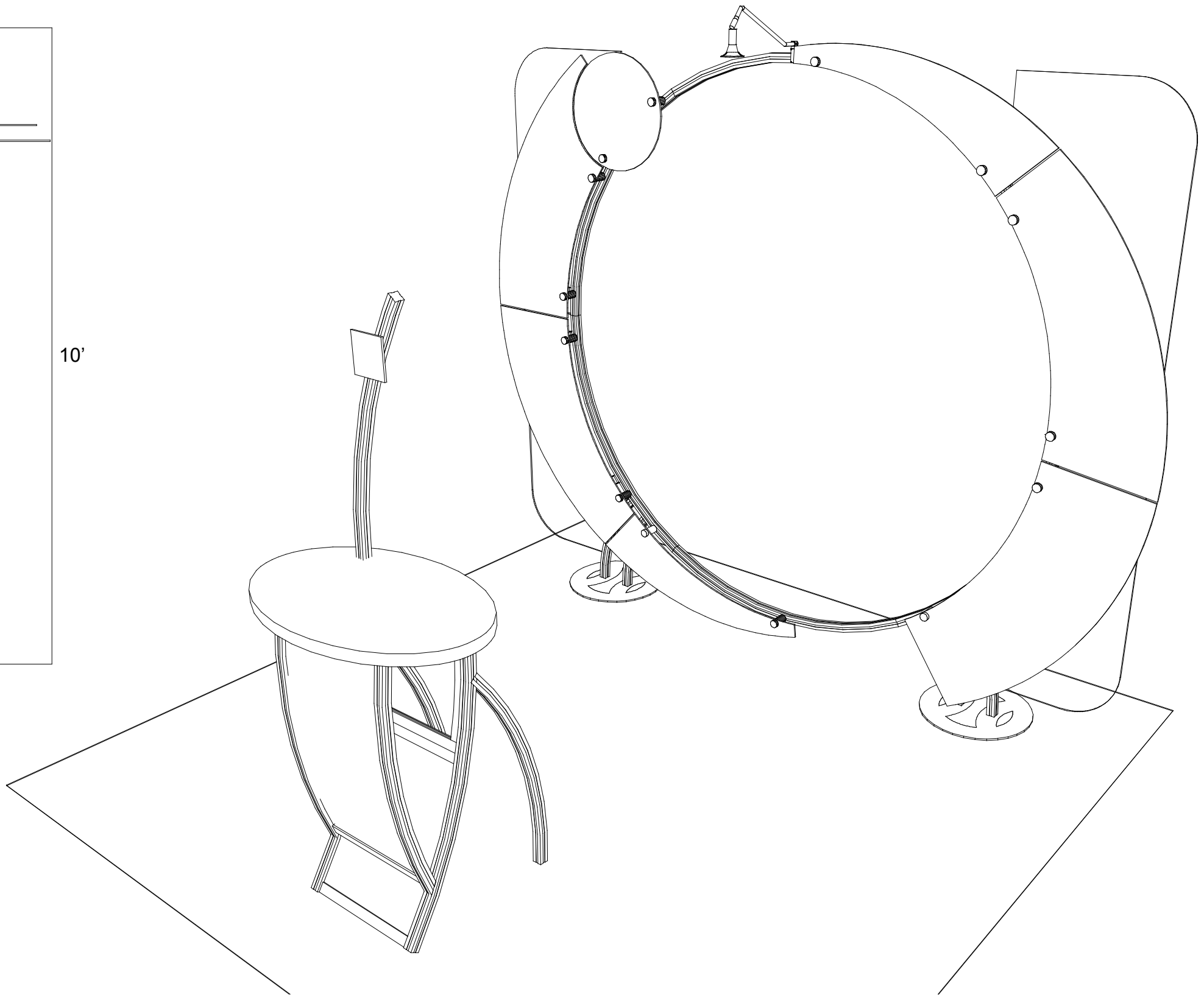

visionary[™]
DESIGNS

WHEN DISASSEMBLING ALUMINUM EXTRUSION, TIGHTEN ALL SETSCREWS AND LOCKS TO PREVENT LOSS DURING SHIPPING

visionary™ IDESIGNS

Using Your Setup Instructions

The Visionary Designs Setup Instructions are created specifically for your configuration. They are laid out sequentially, including an exploded view of the entire display, and then a logical series of detailed steps to assemble the main structure and components. We encourage you to study the instructions **before** attempting to assemble your exhibit.

Each page reminds you to tighten the setscrews after disassembling your exhibit to prevent loss of the locks and setscrews (see below in RED). This is **VERY IMPORTANT**.

Cleaning and Packing Your Display

- 1) Use care when cleaning aluminum extrusion or acrylic inserts. Use only non-abrasive cleaners.
- 2) When cleaning laminate inserts or countertops, use mild cleansers and a soft material such as cotton.
- 3) Keep all display components away from extreme heat and long exposure to sunlight to avoid warping and fading.
- 4) Retain all packing material. It will make re-packing much easier and will reduce the likelihood of shipping damage.



The Tool

Most Visionary Designs exhibits can be assembled with the supplied Hex Key Tool. Occasionally, a flat head screwdriver may be required.



Detail A

Typical Connection



Typical Connection (cont'd)

Most horizontal extrusion connections have a patented expandable lock. This lock inserts into the groove of an opposing extrusion. Tightening the lock with the Hex Key Tool expands the lock and creates a strong positive connection.

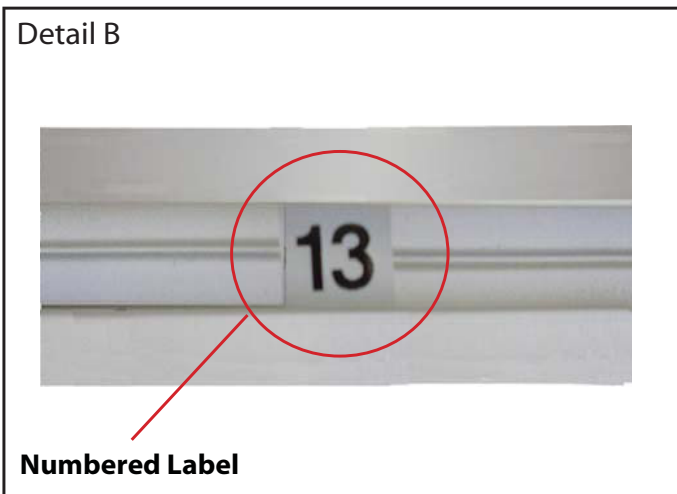

Detail B

Numbered Label

Each extrusion contains a numbered label which corresponds with setup instructions. The label is located within a groove of the extrusion (when possible). With Visionary Designs the labels contain Black numbers unless otherwise specified.



Detail C

Horizontal Inline Connection (remove only one setscrew)

Remove only (1) setscrew when disassembling. Replace setscrew in extrusion after assembling it. Before packing, replace setscrew in extrusion to avoid losing it.

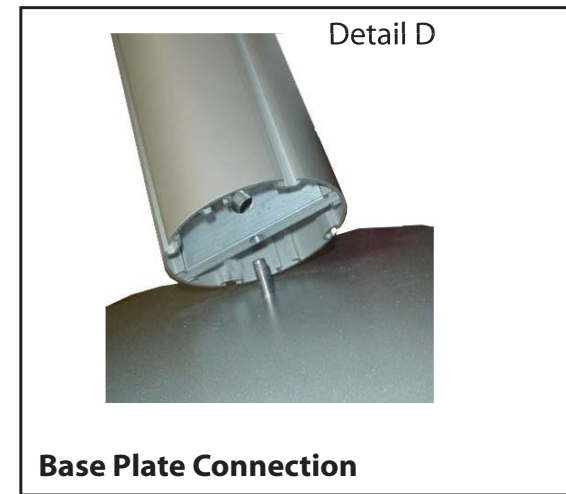

Detail D

Base Plate Connection

Attach base plate to round or square vertical extrusion using the bolt provided. Be careful not to strip the threads.

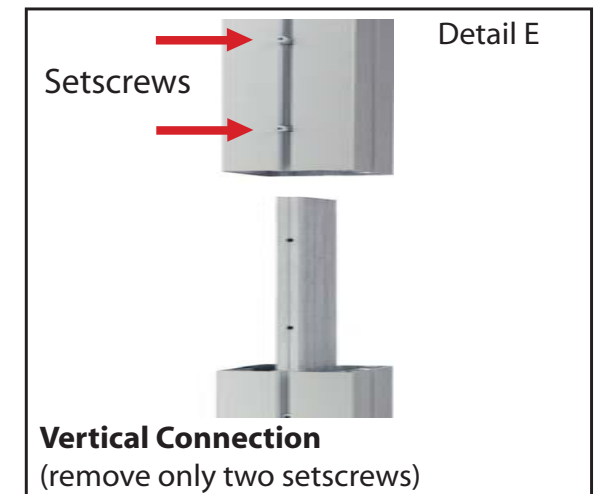

Detail E

Vertical Connection
(remove only two setscrews)

When vertical extrusions are packed in portable cases rather than crates or tubs, they must be broken down into smaller sections which then require assembly.

Remove only (2) setscrews when disassembling. Replace setscrews in extrusion after assembling it. Before packing, replace setscrews in extrusion to avoid losing them.

WHEN DISASSEMBLING ALUMINUM EXTRUSION, TIGHTEN ALL SETSCREWS AND LOCKS TO PREVENT LOSS DURING SHIPPING

866.652.2100

Item	Qty.	Description
1	2	Base Plate
2	1	47.1239" Curved Extrusion
3	1	Curved Leg Assembly
4	1	47.1239" Curved Extrusion
5	1	47.1239" Curved Extrusion
6	1	47.1239" Curved Extrusion
7	1	Curved Leg Assembly

Steps:

- 1) Attach base plates [1] to curved leg assemblies [3,7].
- 2) Attach curved extrusion [2] between two leg assemblies [3,7].
- 3) Attach other curved extrusions between two leg assemblies [3,7].

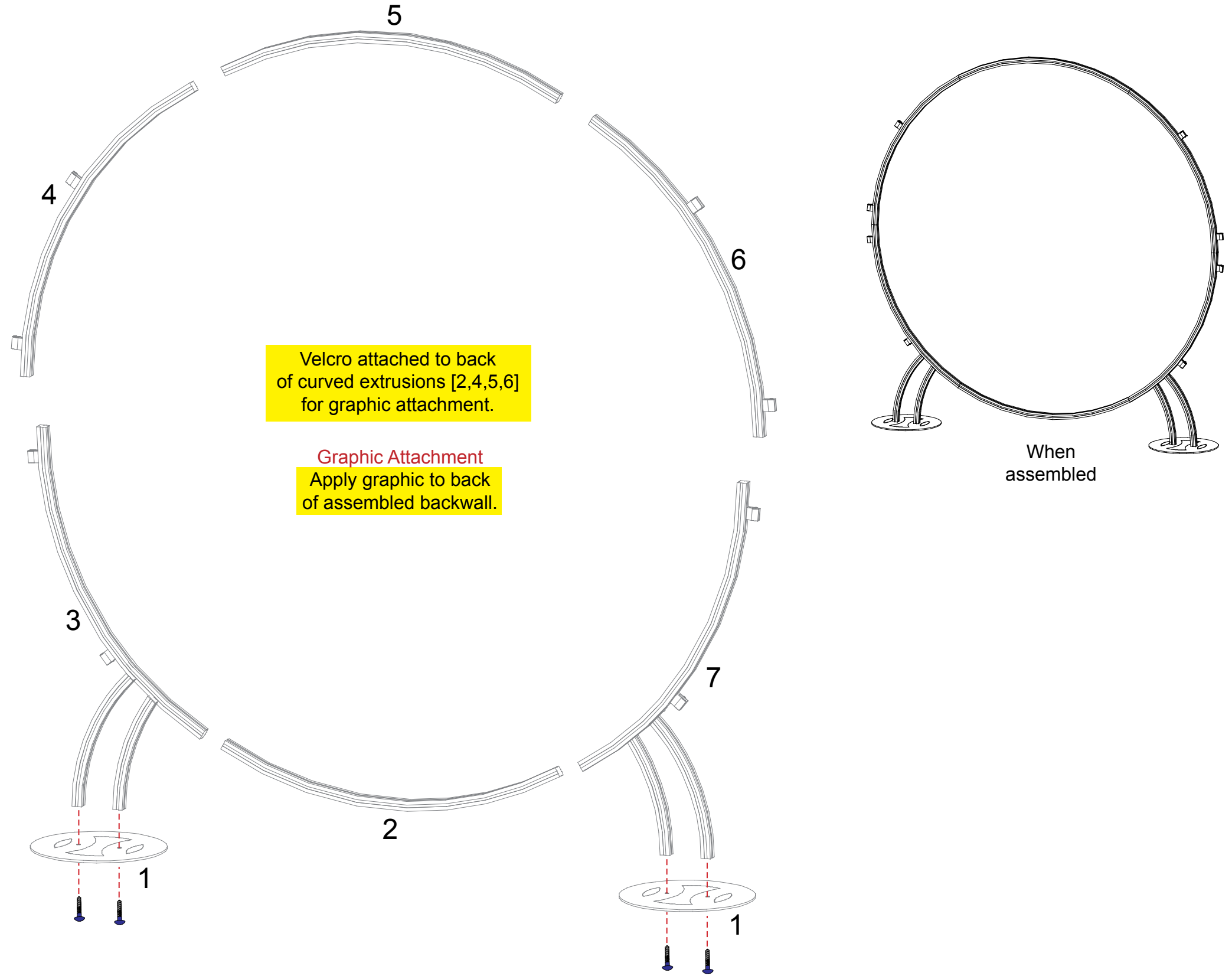

WHEN DISASSEMBLING ALUMINUM EXTRUSION, TIGHTEN ALL SETSCREWS AND LOCKS TO PREVENT LOSS DURING SHIPPING

Steps:

- 1) Attach wings to assembled round frame as shown. Refer to A10 clamp detail.

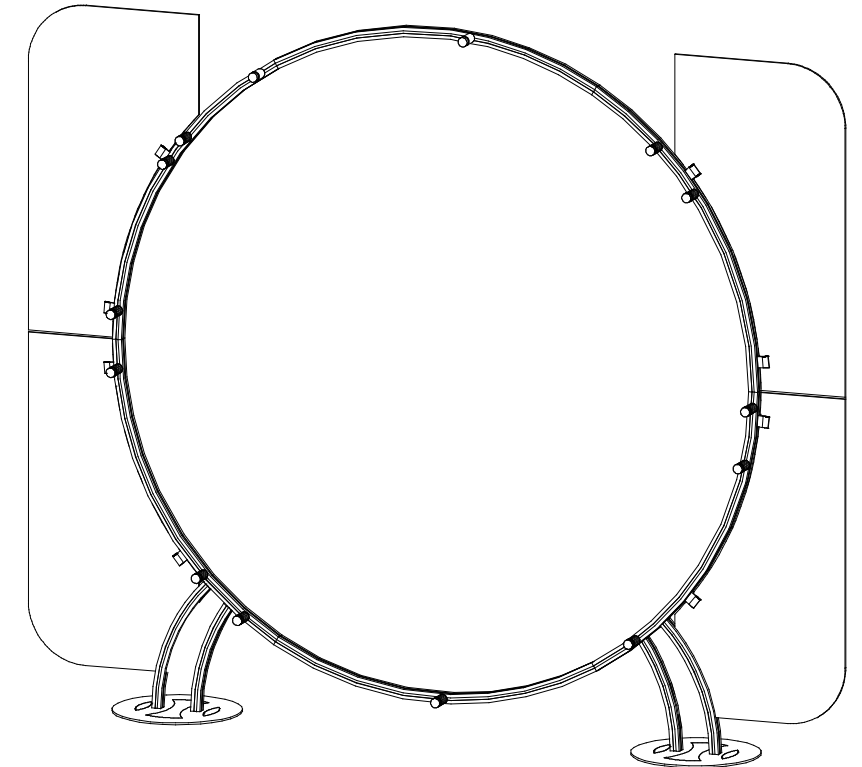
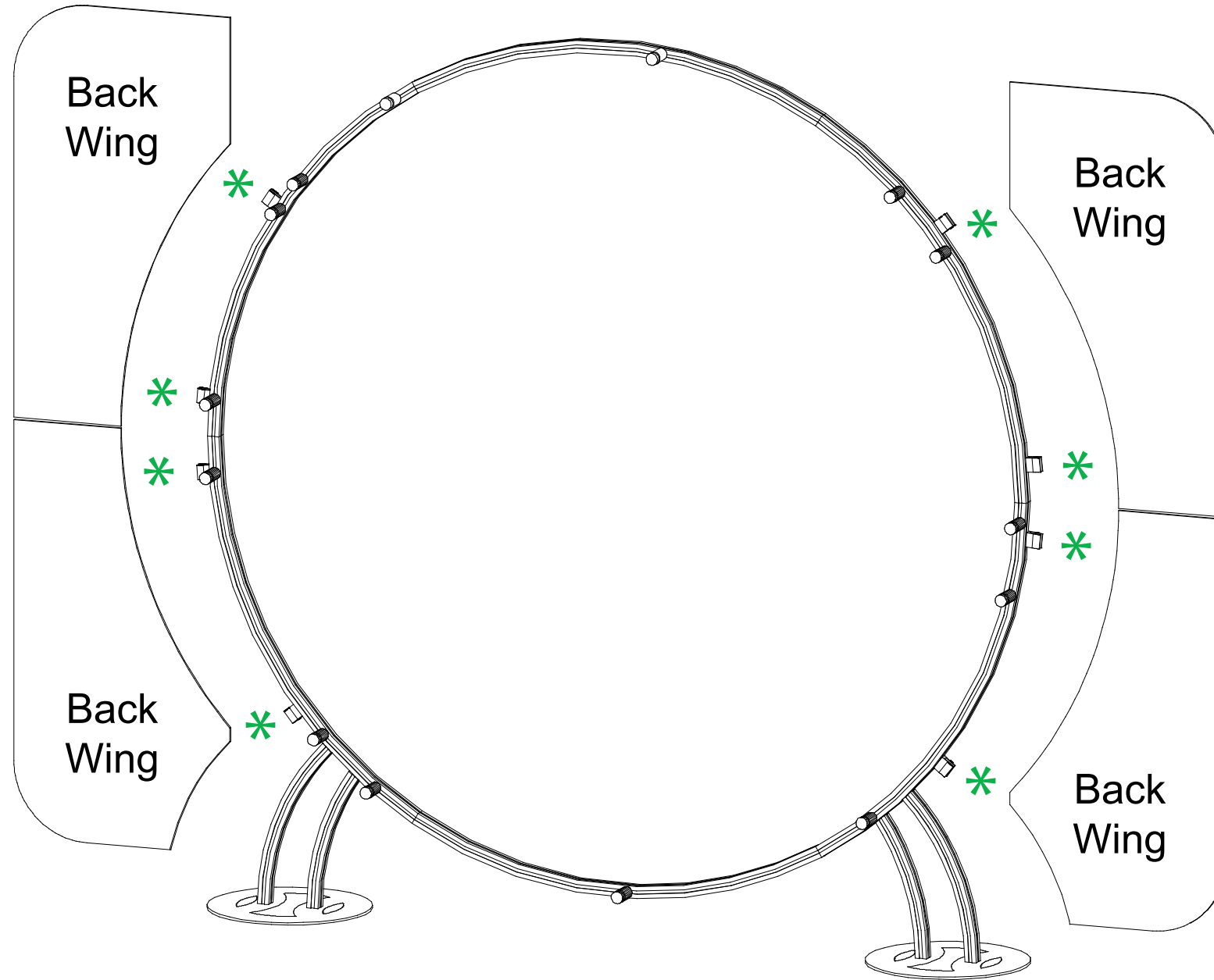

A10 Clamp Detail

Tighten set screw to secure A10 to extrusion.

Tighten knob to secure header/wing in place.

The diagram shows a cross-section of an aluminum extrusion with an A10 clamp. A set screw is shown being tightened into the extrusion. Below, a knob is shown being tightened to secure a header/wing in place. A green asterisk (*) is placed next to the knob.

WHEN DISASSEMBLING ALUMINUM EXTRUSION, TIGHTEN ALL SETSCREWS AND LOCKS TO PREVENT LOSS DURING SHIPPING

866.652.2100

Steps:

- 1) Attach front wings and round graphic header to assembled round frame as shown. Refer to *Graphic Attachment* detail.
- 2) Attach a light to top of assembled round frame. Refer to *Light Connection* detail.

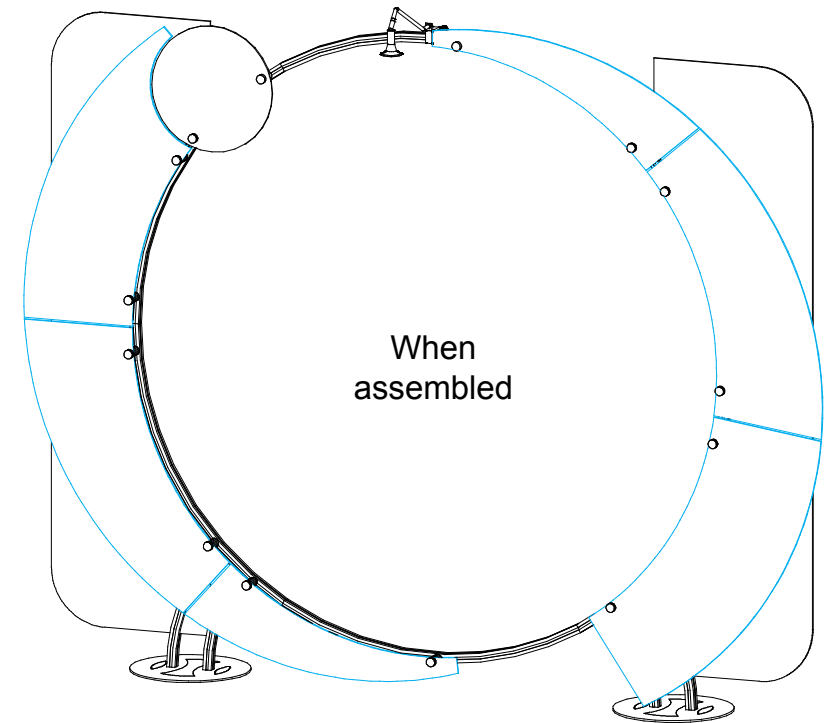
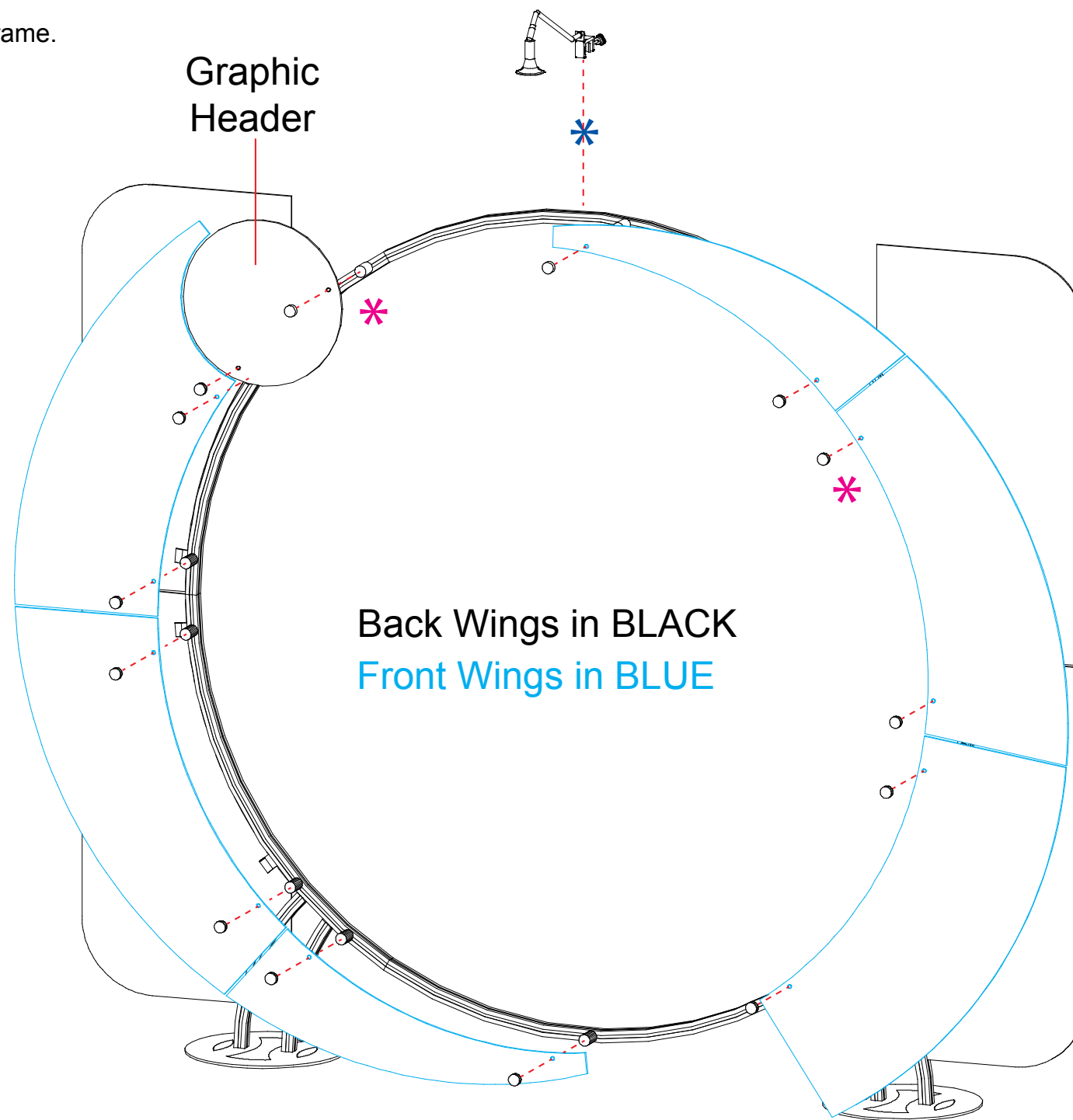

*** Graphic Attachment**

Graphic

Cap

Standoff Barrel

Slide connector on back of standoff barrels into groove of extrusion and twist to secure in place. Secure graphic to standoffs using screw caps.

Light Connection

Attach lights to backwall where desired and tighten in place.

WHEN DISASSEMBLING ALUMINUM EXTRUSION, TIGHTEN ALL SETSCREWS AND LOCKS TO PREVENT LOSS DURING SHIPPING

Part Number	Description
A	Left Leg Assembly
B	Right Leg Assembly
C	Horizontal Extrusion
D	Horizontal Extrusion w/ Door Stopper

Steps:

- 1) Connect lower horizontal extrusion [C] between bottom of leg assemblies [A and B] as shown.
- 2) Insert Laminated infill into grooves of leg assemblies [A and B].
- 3) Attach extrusion door between leg assemblies [A and B] and on top of laminated infill.
- 4) Attach upper horizontal extrusion w/ door stopper [D] between leg assemblies [A and B], and set flush with top of legs [A and B].

NOTE: Make sure the lock is flush with extrusion before tightening. If lock will not fully engage, gently rock lock and extrusion back and forth while turning knob until lock fully opens.

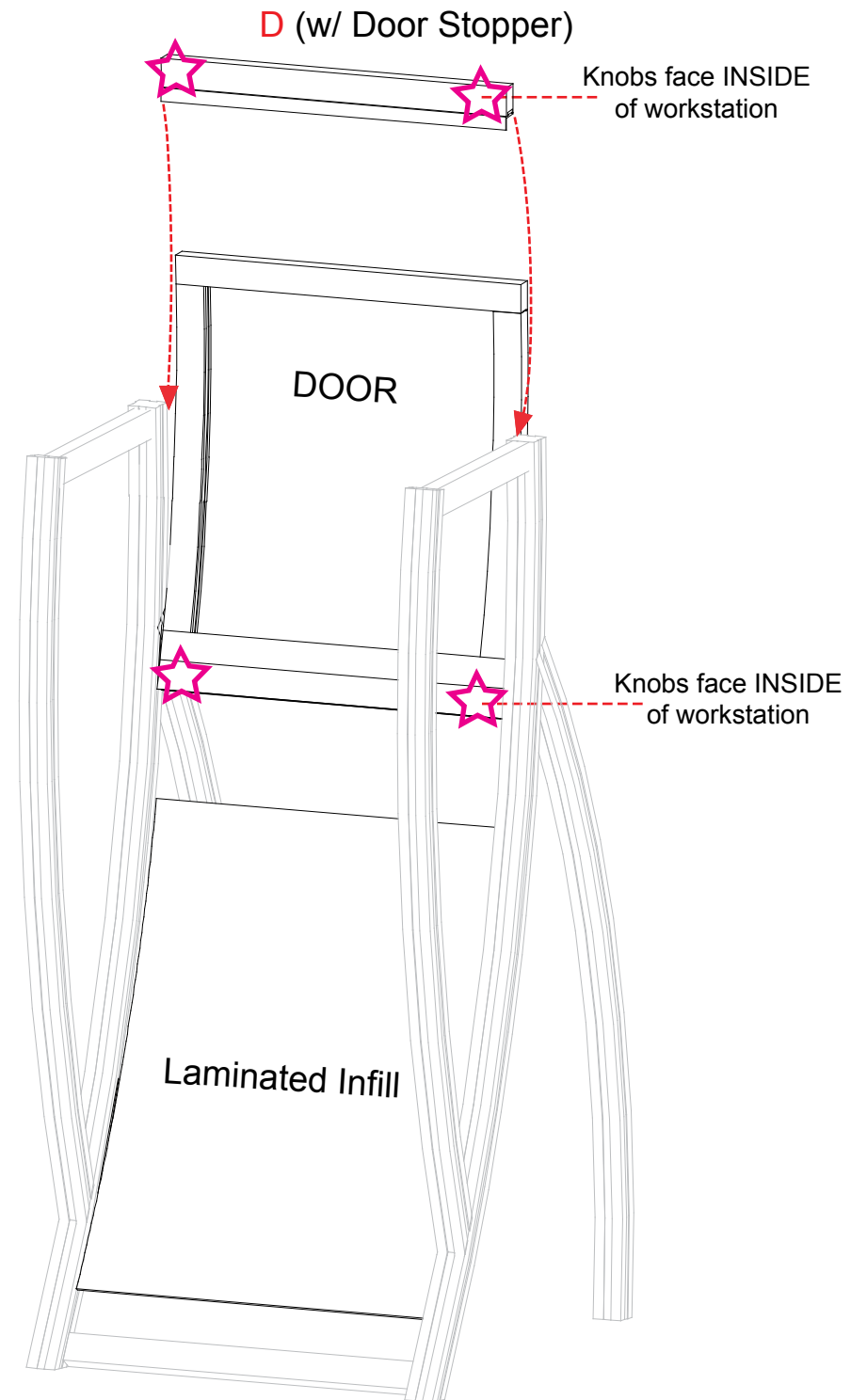
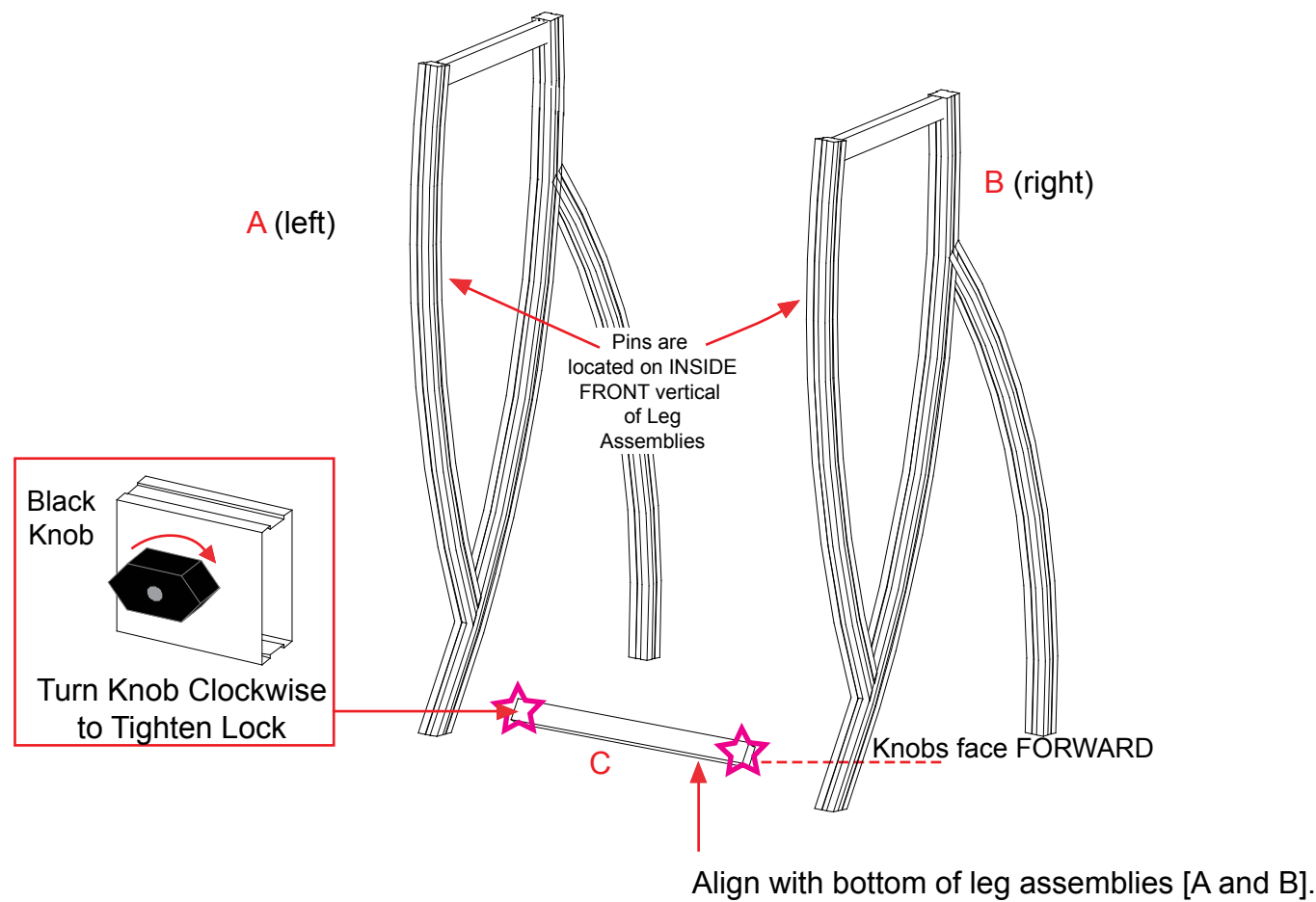

WHEN DISASSEMBLING ALUMINUM EXTRUSION, TIGHTEN ALL SETSCREWS AND LOCKS TO PREVENT LOSS DURING SHIPPING

866.652.2100

Part Number	Description
E	Horizontal Extrusion
F	Horizontal Extrusion

Steps:

- 1) Attach horizontal extrusion [E] between vertical leg assemblies [A and B] as shown below.
- 2) Insert Laminated infill into grooves of vertical leg assemblies [A and B].
- 3) Attach upper horizontal extrusion [F] between vertical leg assemblies [A and B] on top of infill.
- 4) Place internal shelf into assembled pedestal on top of pins.
- 5) Set Counter on top of assembled pedestal and secure with Velcro straps attached to underside of top.

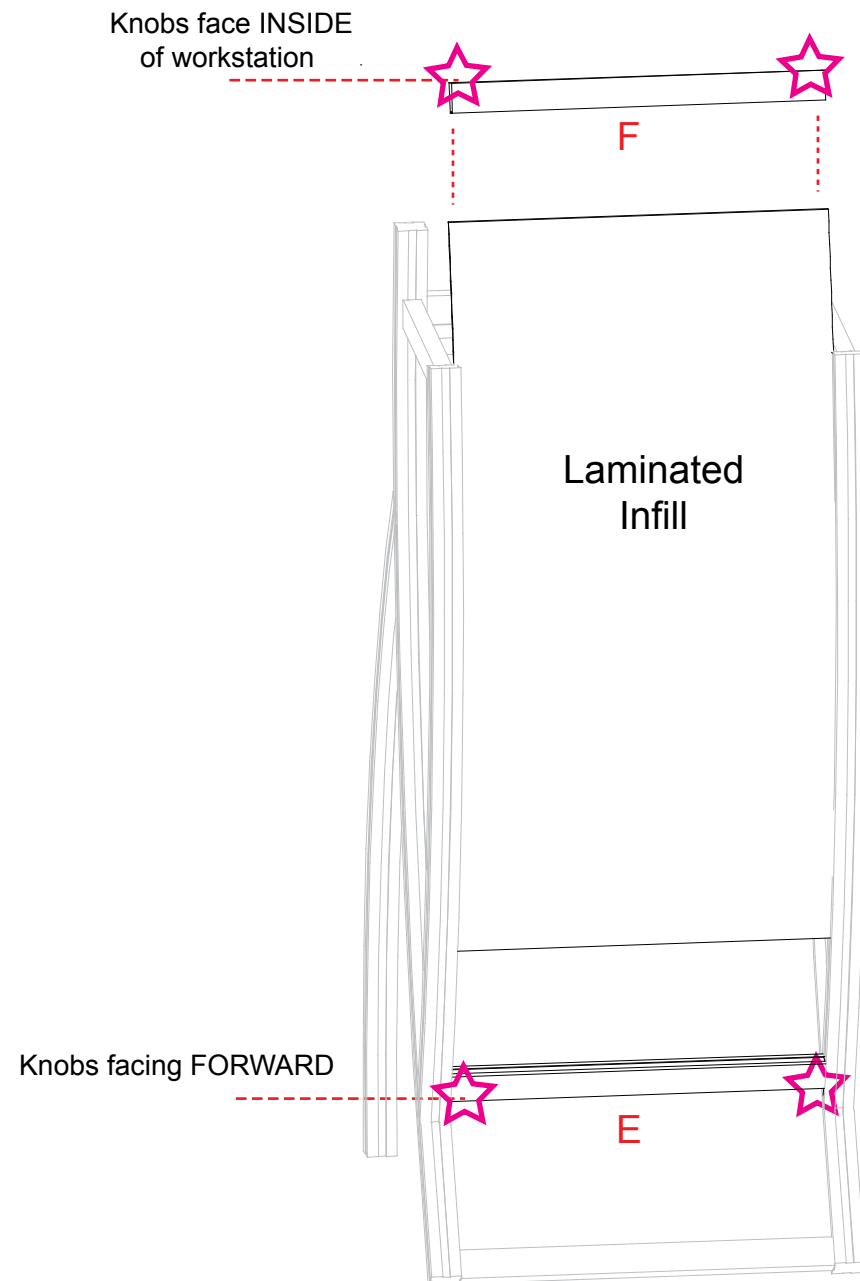

Place internal shelf into workstation then place counter on top of assembled workstation.

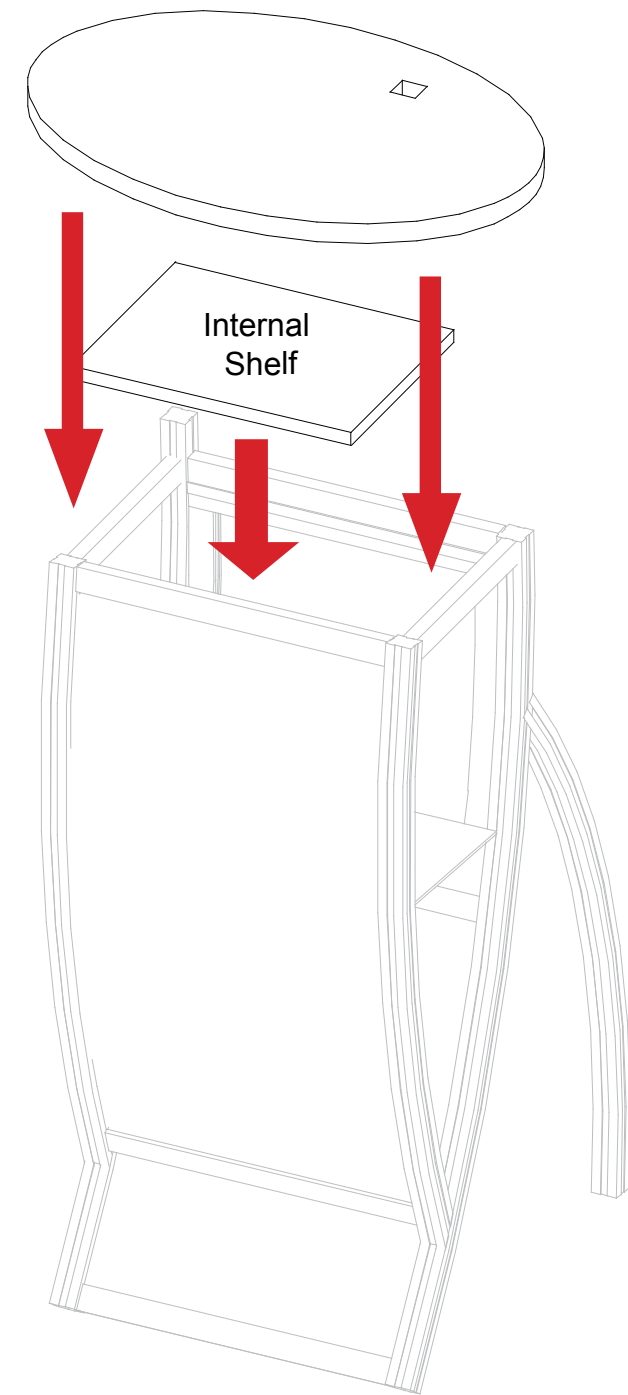

WHEN DISASSEMBLING ALUMINUM EXTRUSION, TIGHTEN ALL SETSCREWS AND LOCKS TO PREVENT LOSS DURING SHIPPING

866.652.2100

Part Number	Description
G	Curved Montior Mount Extrusion

Steps:

- 1) Slide Connection Bar into lower leg assembly. Slide upper vertical over bar and secure both.
- 2) Attach Monitor Mount to vertical as shown in Detail below.

Monitor Mount Attachment

NOTE: Monitor mount should be installed while laying down on floor

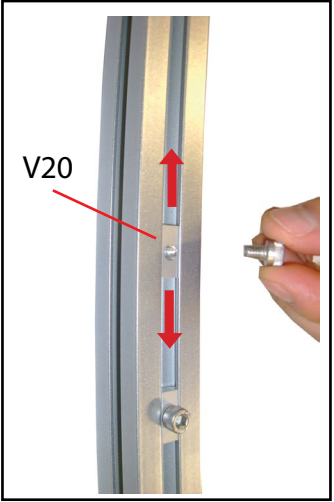

V20

Adjust V20 connector to desired location. Then remove screws.

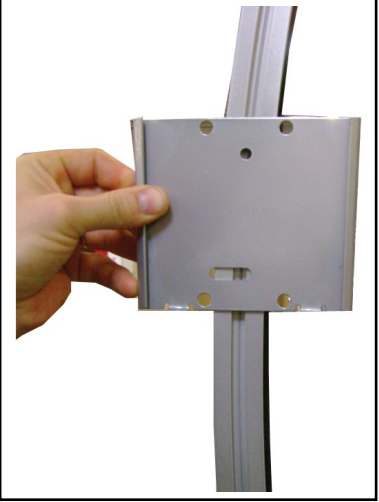

Place mount plate in front of V20 connectors. Then secure with screws.

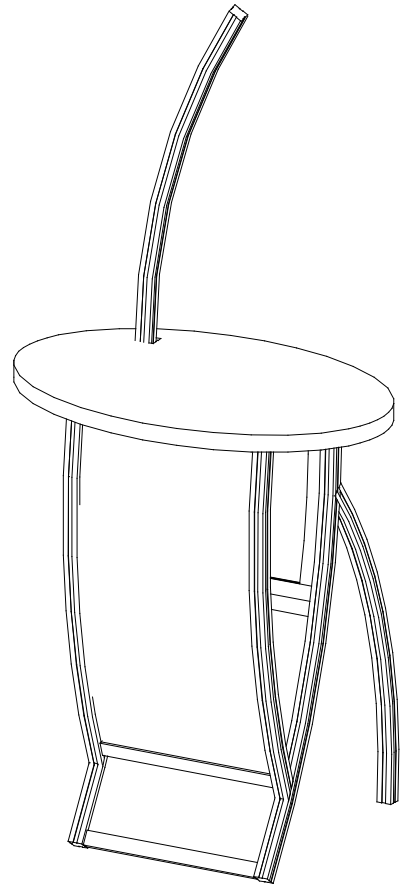
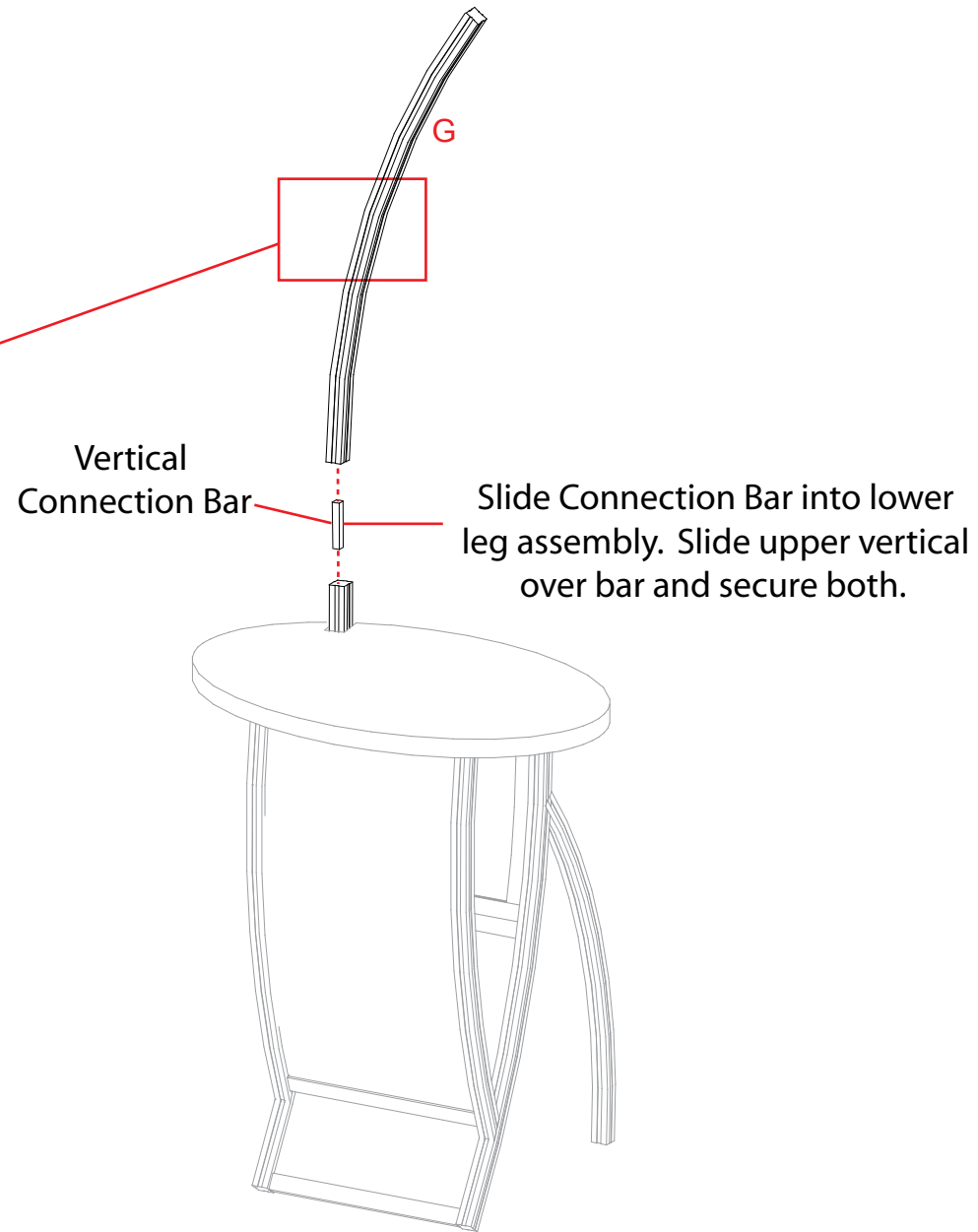

WHEN DISASSEMBLING ALUMINUM EXTRUSION, TIGHTEN ALL SETSCREWS AND LOCKS TO PREVENT LOSS DURING SHIPPING

Top View of Each Level

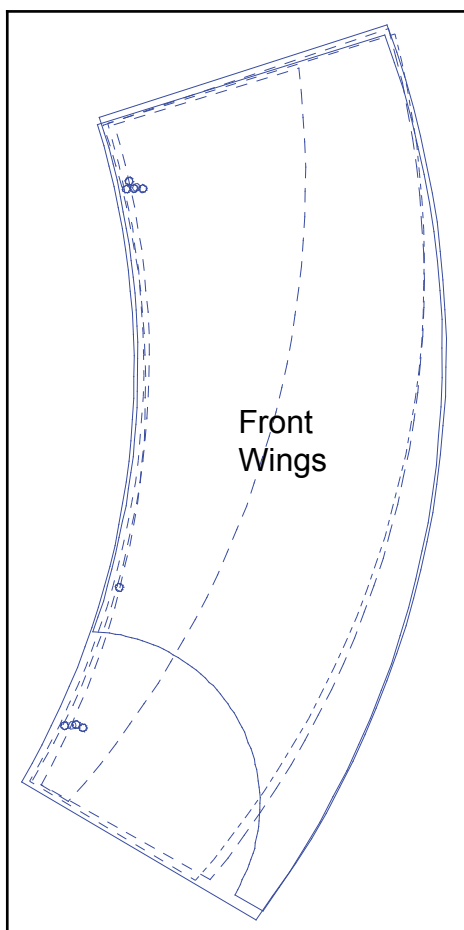

Level 1

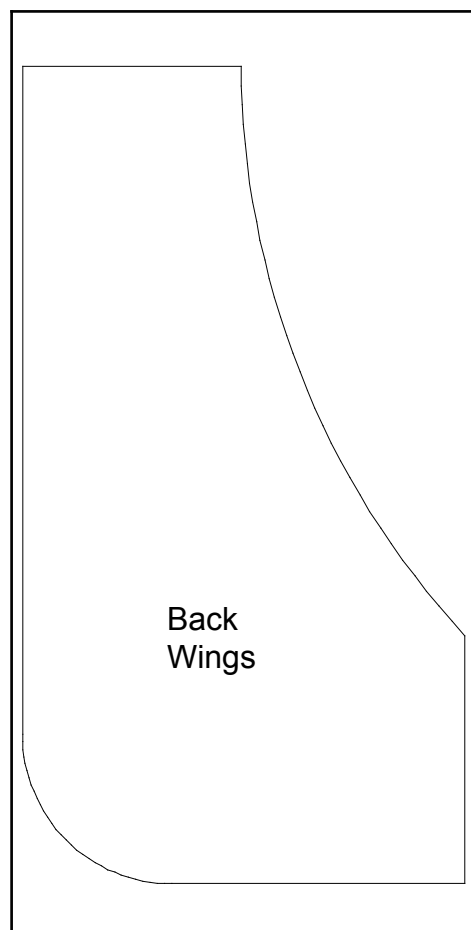

Level 2

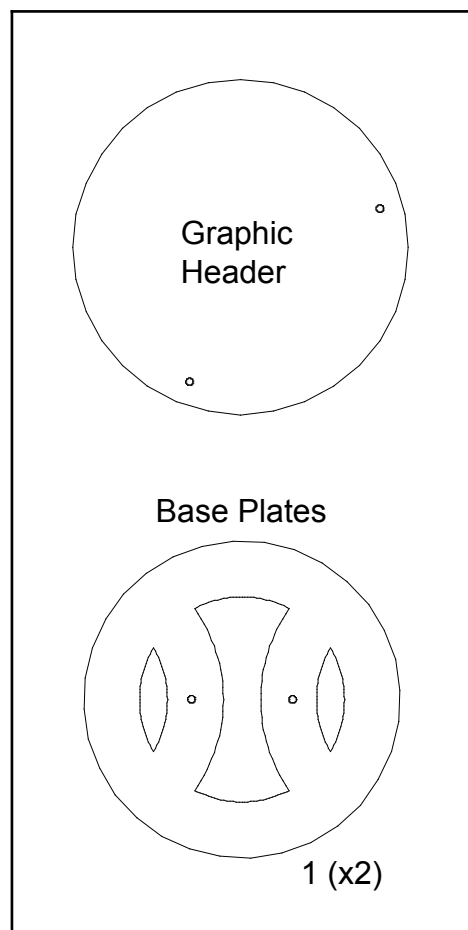

Level 3

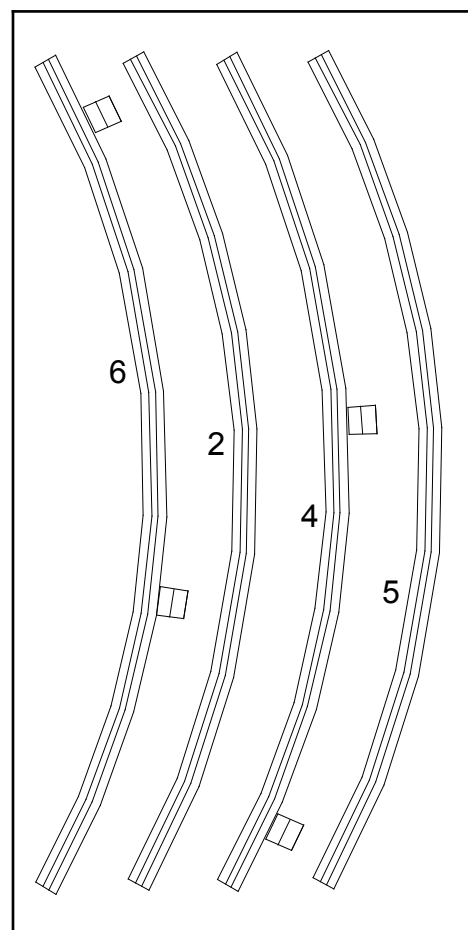

Level 4

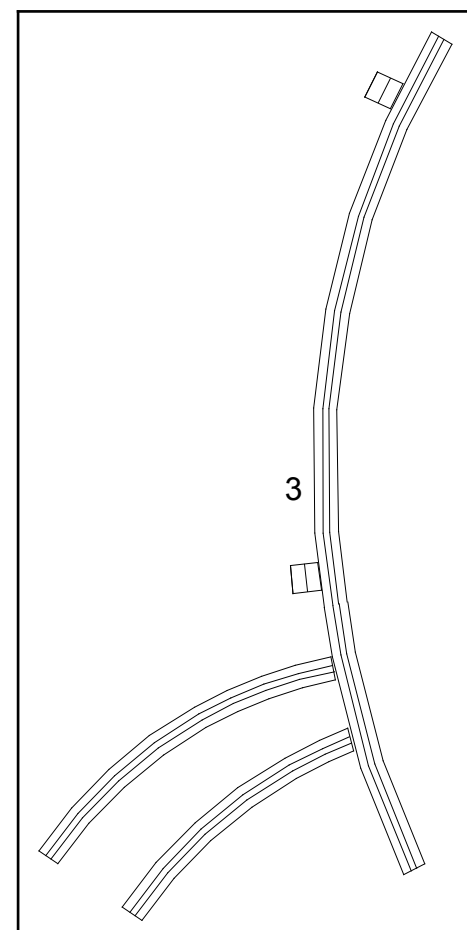

Level 5

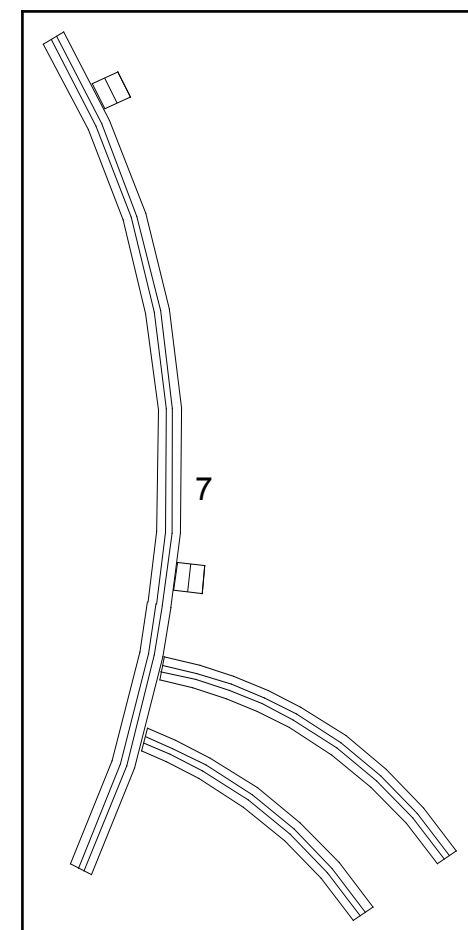

Level 5

Additional Items:
Halogen Lights
Graphics
Setup Hardware

WHEN DISASSEMBLING ALUMINUM EXTRUSION, TIGHTEN ALL SETSCREWS AND LOCKS TO PREVENT LOSS DURING SHIPPING

Top View of each Level

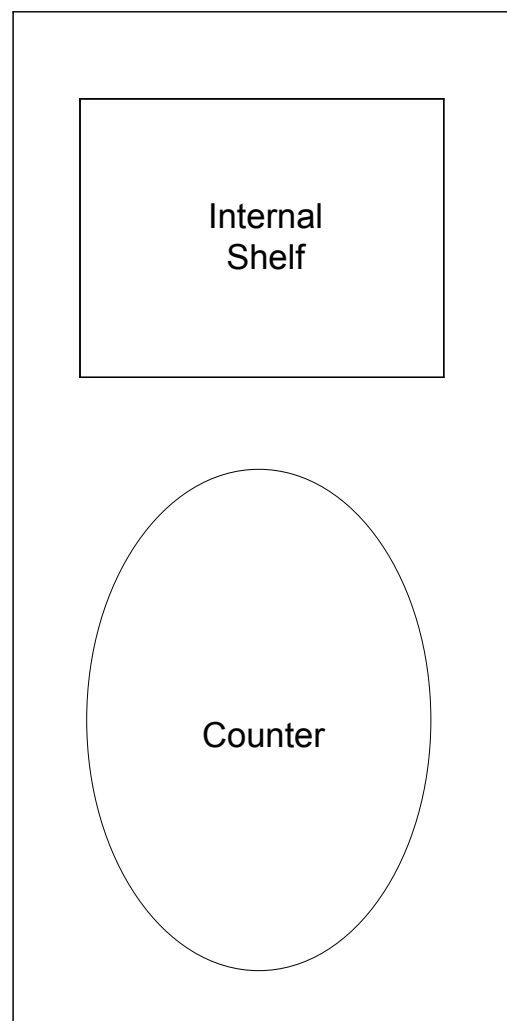

Level 1

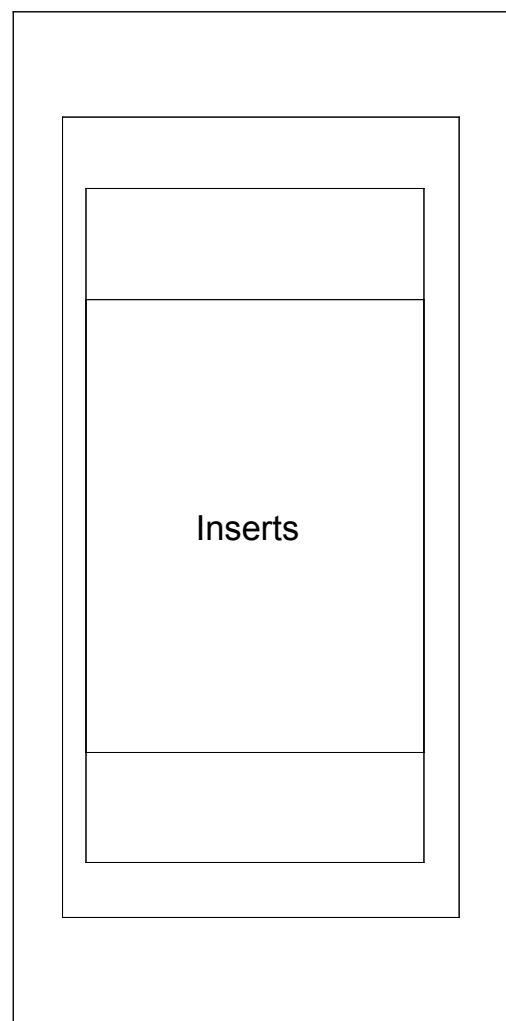

Level 2

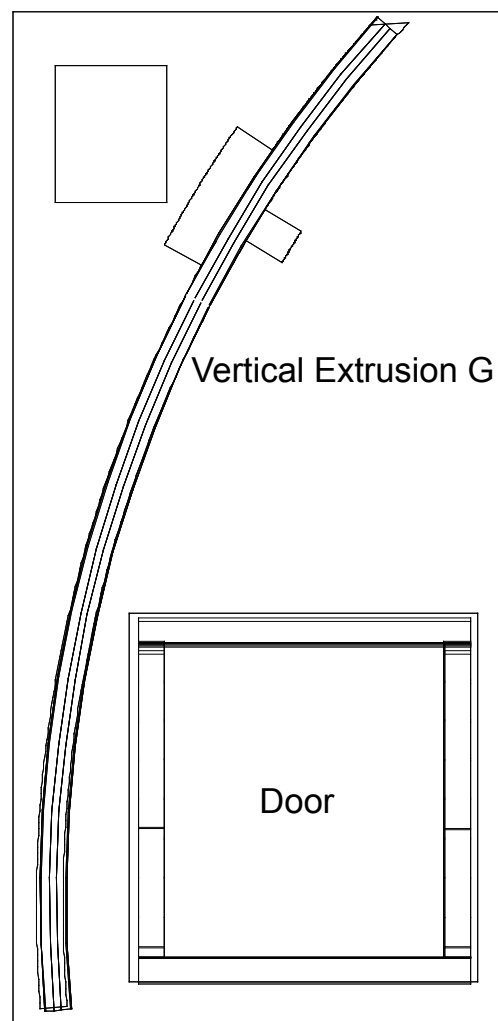

Level 3

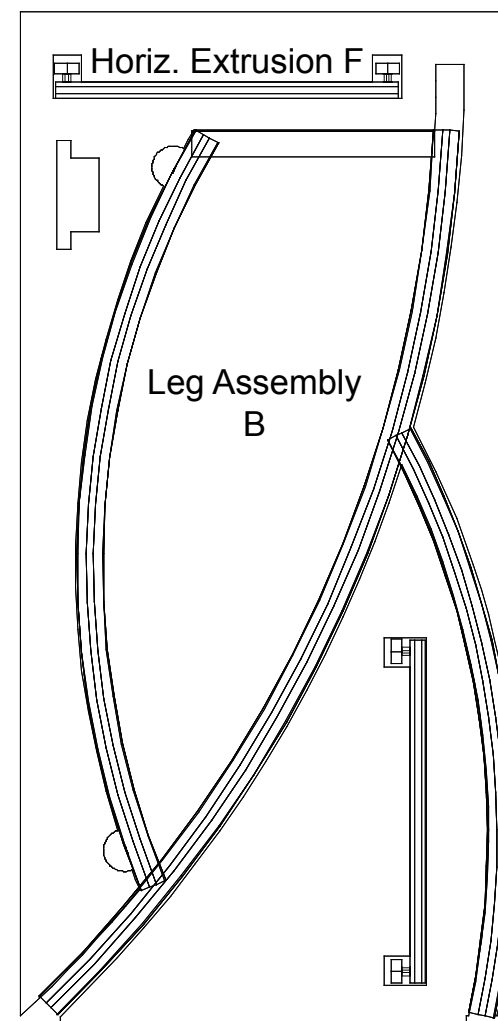

Level 4

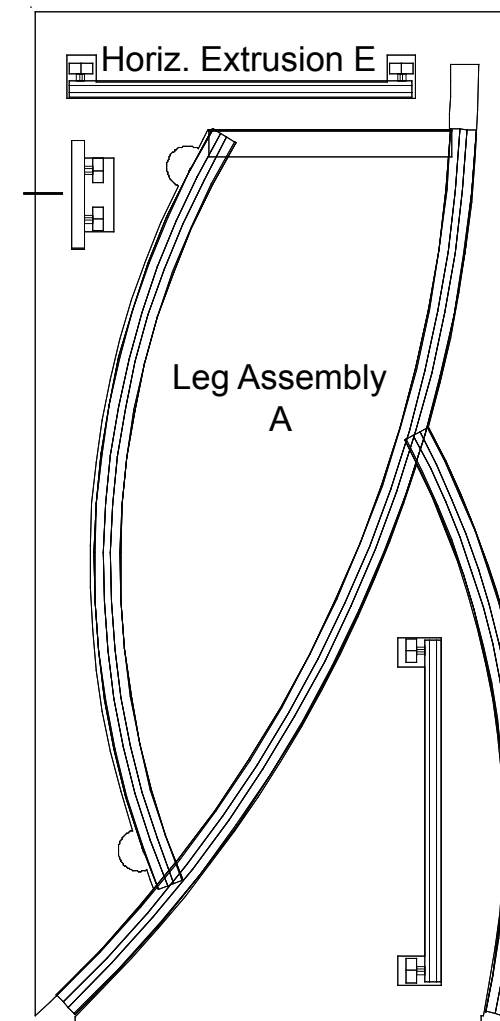

Level 5

WHEN DISASSEMBLING ALUMINUM EXTRUSION, TIGHTEN ALL SETSCREWS AND LOCKS TO PREVENT LOSS DURING SHIPPING